

## Wind-Driven Rain Louver Vertical Blade

### Application and Design

VAVH-5 is a Wind-Driven Rain louver designed to protect air intake and exhaust openings in building exterior walls that are sensitive to direct water penetration. Design incorporates a drainable head member and vertical rain resistant blades to provide maximum resistance to wind driven rain in even the most extreme weather conditions. The VAVH-5 is tested in accordance with AMCA 500-L air performance, water penetration and wind driven rain enabling designers to select and apply with confidence.

### Standard Construction

**Frame** . . . . . Heavy gauge extruded 6063-T5 aluminum, 5 in. x 0.081 in. nominal wall thickness

**Blades** . . . . . Vertical rain resistant style, heavy gauge extruded 6063-T5 aluminum, 0.060 in. nominal wall thickness, positioned on approximately 1.5 in. blade spacing

**Construction** . . . Mechanically fastened

**Birdscreen** . . . . . 3/4 in. x 0.051 in. flattened expanded aluminum in removable frame, inside mount (rear)

**Finish** . . . . . Mill

**Minimum Size** . . . 12 in. W x 12 in. H

**Maximum Single Section Size** . . . 60 in. W x 96 in. H

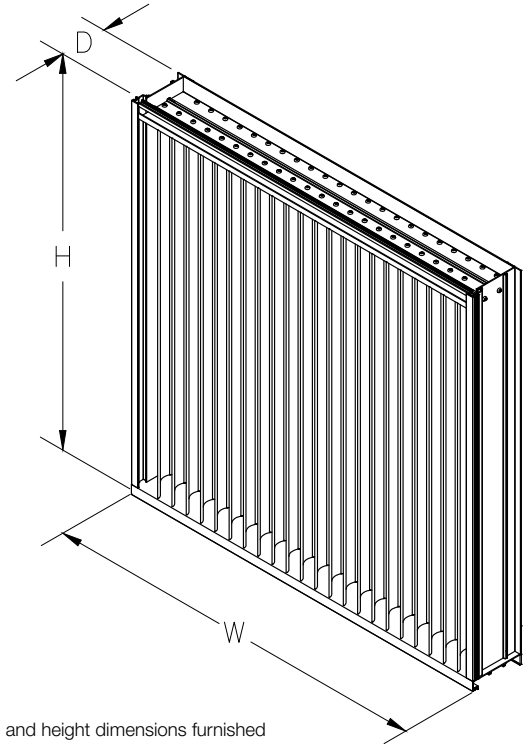
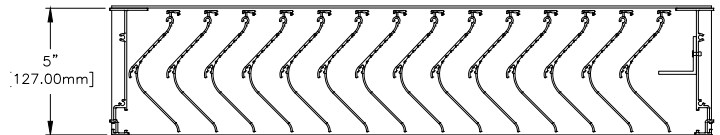

\*Width and height dimensions furnished approximately 1/4 inch under size.

### Options (at additional cost)

- A variety of bird and insect screens
- Blank-off panel
- Clip angles
- Extended sill
- Filter rack
- Flanged frame (*head and jamb only*)
- Security bars
- A variety of architectural finishes including:
  - Clear anodize
  - Integral color anodize
  - Baked enamel
  - Kynar

# PERFORMANCE DATA

# VAVH-5

## Wind-Driven Rain Performance

## Aluminum Wind-Driven Rain Louver Vertical Blade

| 75 mm/h (3 in./hr) Rainfall & 13 m/s (29 mph) Wind Velocity |       |                               |       |                   | 202 mm/h (8 in./hr) Rainfall & 22 m/s (50 mph) Wind Velocity |                    |       |                               |       |                   |           |
|---|-------|-------------------------------|-------|-------------------|--|--------------------|-------|-------------------------------|-------|-------------------|-----------|
| Free Area Velocity  |       | Ventilation Air Core Velocity |       | Water Penetration |  | Free Area Velocity |       | Ventilation Air Core Velocity |       | Water Penetration |           |
| (fpm)   | (m/s) | (fpm)                         | (m/s) | Class             | Effective  | (fpm)              | (m/s) | (fpm)                         | (m/s) | Class             | Effective |
| 0   | 0     | 0                             | 0.0   |                   |  | 0                  | 0     | 0                             | 0.0   |                   |           |
| 167   | 0.9   | 98                            | 0.5   |                   |  | 167                | 0.9   | 98                            | 0.5   |                   |           |
| 335   | 1.7   | 197                           | 1.0   |                   |  | 335                | 1.7   | 197                           | 1.0   |                   |           |
| 502   | 2.6   | 295                           | 1.5   |                   |  | 502                | 2.6   | 295                           | 1.5   |                   |           |
| 669   | 3.4   | 394                           | 2.0   |                   |  | 669                | 3.4   | 394                           | 2.0   |                   |           |
| 837   | 4.3   | 492                           | 2.5   |                   |  | 837                | 4.2   | 492                           | 2.5   |                   |           |
| 1004  | 5.1   | 591                           | 3.0   |                   |  | 1004               | 5.1   | 591                           | 3.0   |                   |           |
| 1172  | 6.0   | 689                           | 3.5   |                   |  | 1173               | 6.0   | 690                           | 3.5   | A                 | 99.7      |
| 1339  | 6.8   | 787                           | 4.0   |                   |  | 1338               | 6.8   | 787                           | 4.0   | A                 | 99.5      |
| 1506  | 7.7   | 776                           | 4.5   |                   |  | 1500               | 7.6   | 882                           | 4.5   | A                 | 99.3      |
| 1685  | 8.6   | 991                           | 5.0   | A                 | 100  | 1655               | 8.4   | 973                           | 4.9   | B                 | 98.7      |

| Discharge Loss Coefficient Classifications |                            |
|--|----------------------------|
| Class                                      | Discharge Loss Coefficient |
| 1  | 0.4 and Above              |
| 2  | 0.3 to 0.399               |
| 3  | 0.2 to 0.299               |
| 4  | 0.199 and Below            |

| Wind-driven Rain Penetration Classes |               |
|--------------------------------------|---------------|
| Class                                | Effectiveness |
| A                                    | 1 to 0.99     |
| B                                    | 0.989 to 0.95 |
| C                                    | 0.949 to 0.80 |
| D                                    | Below 0.80    |

Discharge Loss Coefficient Class (Intake) = 2

Weather louvers shall be classified by their ability to reject simulated rain. The table shows different classifications based on the maximum simulated rain penetration per square meter (square feet) of louver. Water penetration rating at a given louver face velocity is determined by the water penetration while the louver is subjected to a selected simulated rainfall rate and wind velocity.

## Airflow Resistance

(Standard Air - .075 lb./ft.<sup>3</sup>; Test Size - 48 in. x 48in.)

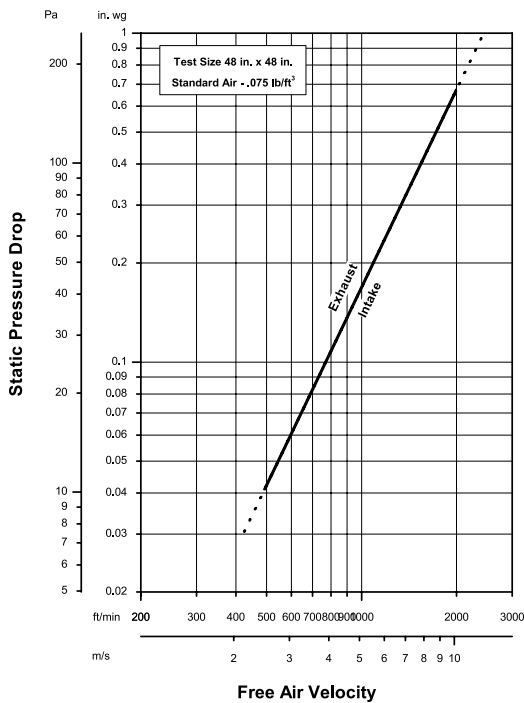

Model VAVH-5 resistance to airflow (pressure drop) varies depending on louver application (air intake or air exhaust). Free area velocities (shown) are higher than average velocity through the overall louver size. See louver selection information. (Test Figure 5.5)

## Water Penetration

(Standard Air - .075 lb./ft.<sup>3</sup>; Test Size - 48 in. x 48 in.; Test Duration - 15 min.)

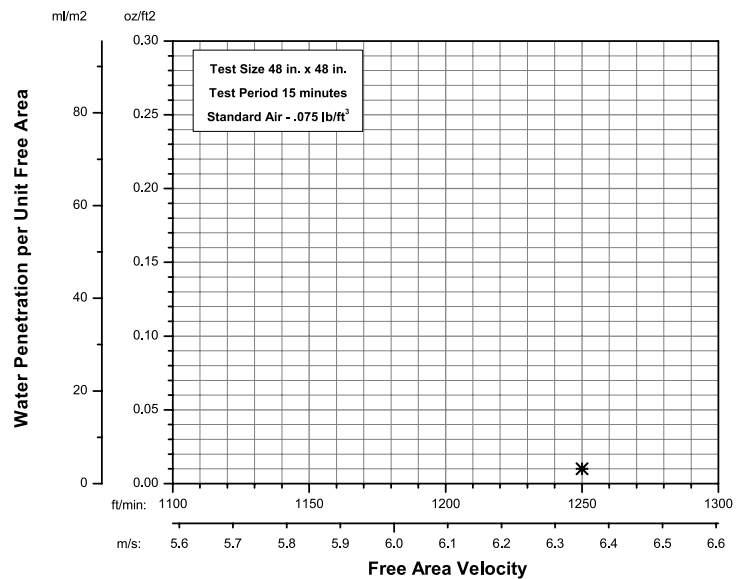

The AMCA Water Penetration Test provides a method for comparing various louver models and designs as to their efficiency in resisting the penetration of rainfall under specific laboratory test conditions. The beginning point of water penetration is defined as that velocity where the water penetration curve projects through 0.01 oz. of water (penetration) per sq. ft. of louver free area. **\*The beginning point of water penetration for Model VAVH-5 is above 1250 fpm free area velocity.** These performance ratings do not guarantee a louver to be weather-proof or stormproof and should be used in combination with other factors including good engineering judgement in selecting louvers.

# PERFORMANCE DATA

# VAVH-5

Aluminum Wind-Driven Rain Louver  
Vertical Blade

## Free Area Chart (sq. ft.)

| Louver Height Inches | Louver Width in Inches |      |      |       |       |       |             |       |       |
|----------------------|------------------------|------|------|-------|-------|-------|-------------|-------|-------|
|                      | 12                     | 18   | 24   | 30    | 36    | 42    | <b>48</b>   | 54    | 60    |
| 12                   | 0.24                   | 0.43 | 0.62 | 0.81  | 1.00  | 1.19  | 1.38        | 1.56  | 1.75  |
| 18                   | 0.46                   | 0.82 | 1.17 | 1.53  | 1.89  | 2.24  | 2.60        | 2.95  | 3.31  |
| 24                   | 0.68                   | 1.20 | 1.72 | 2.25  | 2.77  | 3.30  | 3.82        | 4.34  | 4.87  |
| 30                   | 0.89                   | 1.58 | 2.28 | 2.97  | 3.66  | 4.35  | 5.04        | 5.73  | 6.43  |
| 36                   | 1.11                   | 1.97 | 2.83 | 3.69  | 4.55  | 5.41  | 6.27        | 7.12  | 7.98  |
| 42                   | 1.33                   | 2.35 | 3.38 | 4.41  | 5.43  | 6.46  | 7.49        | 8.51  | 9.54  |
| <b>48</b>            | 1.54                   | 2.74 | 3.93 | 5.13  | 6.32  | 7.52  | <b>8.71</b> | 9.90  | 11.10 |
| 54                   | 1.70                   | 3.02 | 4.35 | 5.67  | 6.99  | 8.31  | 9.63        | 10.95 | 12.27 |
| 60                   | 1.92                   | 3.41 | 4.90 | 6.39  | 7.87  | 9.36  | 10.85       | 12.34 | 13.83 |
| 66                   | 2.14                   | 3.79 | 5.45 | 7.10  | 8.76  | 10.42 | 12.07       | 13.73 | 15.38 |
| 72                   | 2.35                   | 4.18 | 6.00 | 7.82  | 9.65  | 11.47 | 13.29       | 15.12 | 16.94 |
| 78                   | 2.57                   | 4.56 | 6.55 | 8.54  | 10.53 | 12.53 | 14.52       | 16.51 | 18.50 |
| 84                   | 2.79                   | 4.95 | 7.10 | 9.26  | 11.42 | 13.58 | 15.74       | 17.90 | 20.06 |
| 90                   | 3.00                   | 5.33 | 7.66 | 9.98  | 12.31 | 14.64 | 16.96       | 19.29 | 21.61 |
| 96                   | 3.22                   | 5.71 | 8.21 | 10.70 | 13.20 | 15.69 | 18.18       | 20.68 | 23.17 |

## Core Area Chart (sq. ft.)

| Louver Height Inches | Louver Width in Inches |       |       |       |       |       |              |       |       |
|----------------------|------------------------|-------|-------|-------|-------|-------|--------------|-------|-------|
|                      | 12                     | 18    | 24    | 30    | 36    | 42    | <b>48</b>    | 54    | 60    |
| 12                   | 0.66                   | 1.04  | 1.43  | 1.81  | 2.20  | 2.59  | 2.97         | 3.36  | 3.74  |
| 18                   | 1.09                   | 1.72  | 2.36  | 2.99  | 3.63  | 4.26  | 4.90         | 5.53  | 6.17  |
| 24                   | 1.51                   | 2.40  | 3.28  | 4.17  | 5.05  | 5.94  | 6.83         | 7.71  | 8.60  |
| 30                   | 1.94                   | 3.08  | 4.21  | 5.35  | 6.48  | 7.62  | 8.75         | 9.89  | 11.02 |
| 36                   | 2.37                   | 3.75  | 5.14  | 6.52  | 7.91  | 9.29  | 10.68        | 12.06 | 13.45 |
| 42                   | 2.79                   | 4.43  | 6.06  | 7.70  | 9.34  | 10.97 | 12.61        | 14.24 | 15.88 |
| <b>48</b>            | 3.22                   | 5.11  | 6.99  | 8.88  | 10.76 | 12.65 | <b>14.53</b> | 16.42 | 18.30 |
| 54                   | 3.65                   | 5.78  | 7.92  | 10.05 | 12.19 | 14.33 | 16.46        | 18.60 | 20.73 |
| 60                   | 4.08                   | 6.46  | 8.85  | 11.23 | 13.62 | 16.00 | 18.39        | 20.77 | 23.16 |
| 66                   | 4.50                   | 7.14  | 9.77  | 12.41 | 15.04 | 17.68 | 20.31        | 22.95 | 25.59 |
| 72                   | 4.93                   | 7.81  | 10.70 | 13.59 | 16.47 | 19.36 | 22.24        | 25.13 | 28.01 |
| 78                   | 5.36                   | 8.49  | 11.63 | 14.76 | 17.90 | 21.03 | 24.17        | 27.30 | 30.44 |
| 84                   | 5.78                   | 9.17  | 12.55 | 15.94 | 19.33 | 22.71 | 26.10        | 29.48 | 32.87 |
| 90                   | 6.21                   | 9.85  | 13.48 | 17.12 | 20.75 | 24.39 | 28.02        | 31.66 | 35.29 |
| 96                   | 6.64                   | 10.52 | 14.41 | 18.29 | 22.18 | 26.06 | 29.95        | 33.84 | 37.72 |

## Maximum Size and Installation Information

Maximum single section size for model VAVH-5 is 60 in. W x 96 in. H. Larger openings require field assembly of multiple louver sections to make up the overall opening size. Individual louver sections are designed to withstand a 25 PSF wind load (please consult Venco if the louvers must withstand higher wind-loads). Structural reinforcing members may be required to adequately support and install multiple louver sections within a large opening. Structural reinforcing members along with any associated installation hardware is not provided by Venco unless indicated otherwise by Venco. Options and accessories including, but not limited to, screens, filter racks, louver doors, and blank off panels are not subject to structural analysis unless indicated otherwise by Venco.

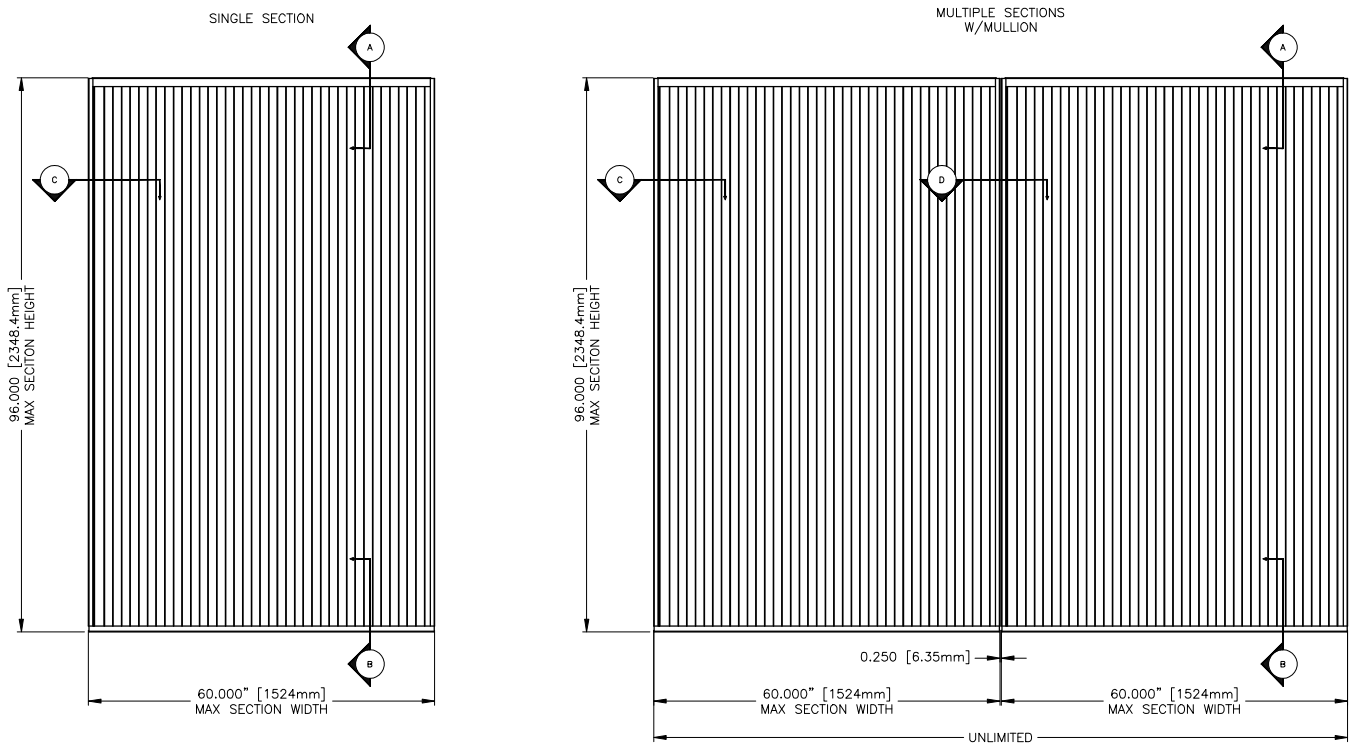

**Minimum Single Section Size**  
12 in. W x 12 in. H

**Maximum Single Section Size**  
60 in. W x 96 in. H

# PRODUCT DETAILS

# VAVH-5

Aluminum Wind-Driven Rain Louver  
Vertical Blade

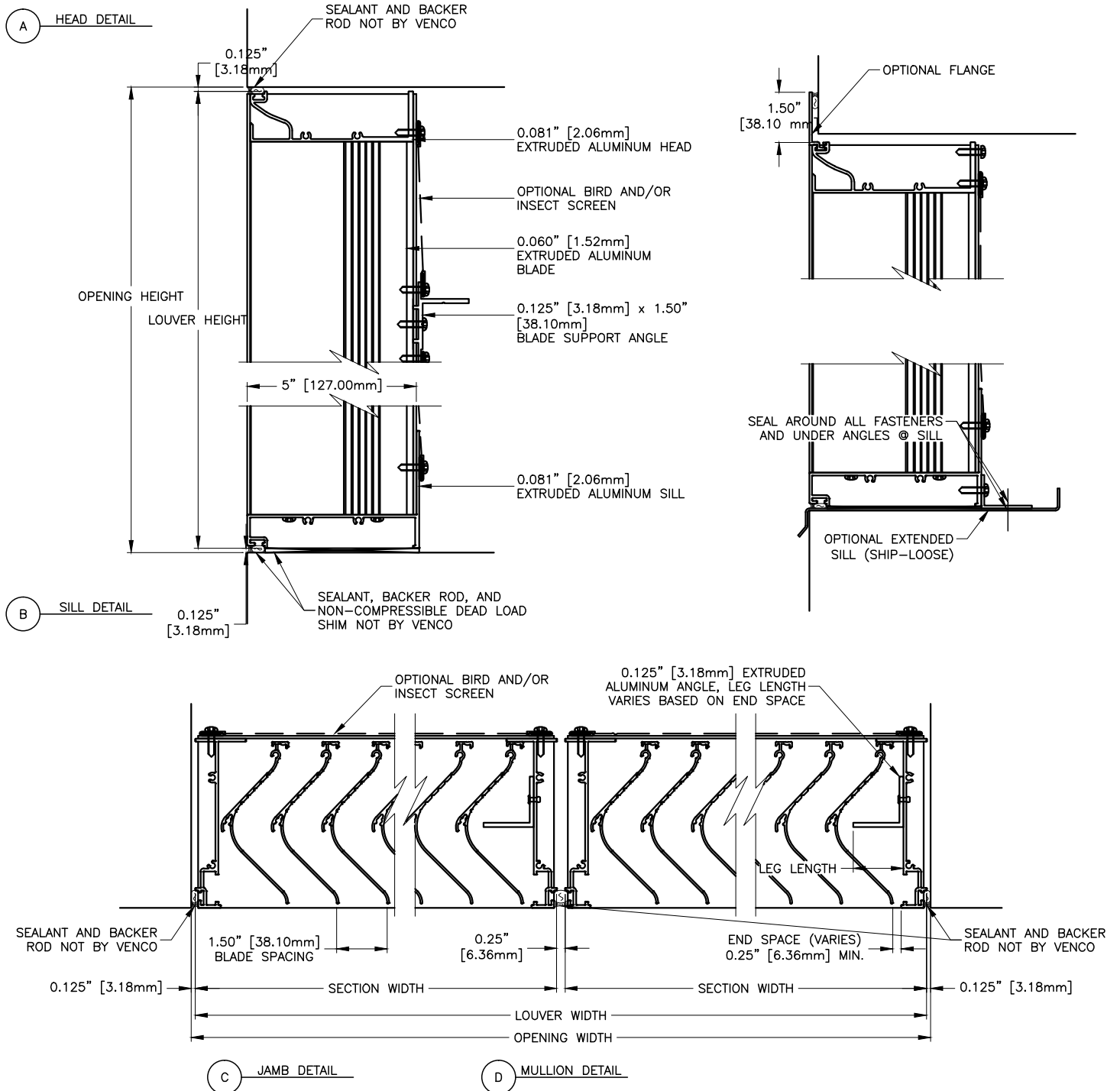

# OPTION DRAWINGS

# VAVH-5

Aluminum Wind-Driven Rain Louver  
Vertical Blade

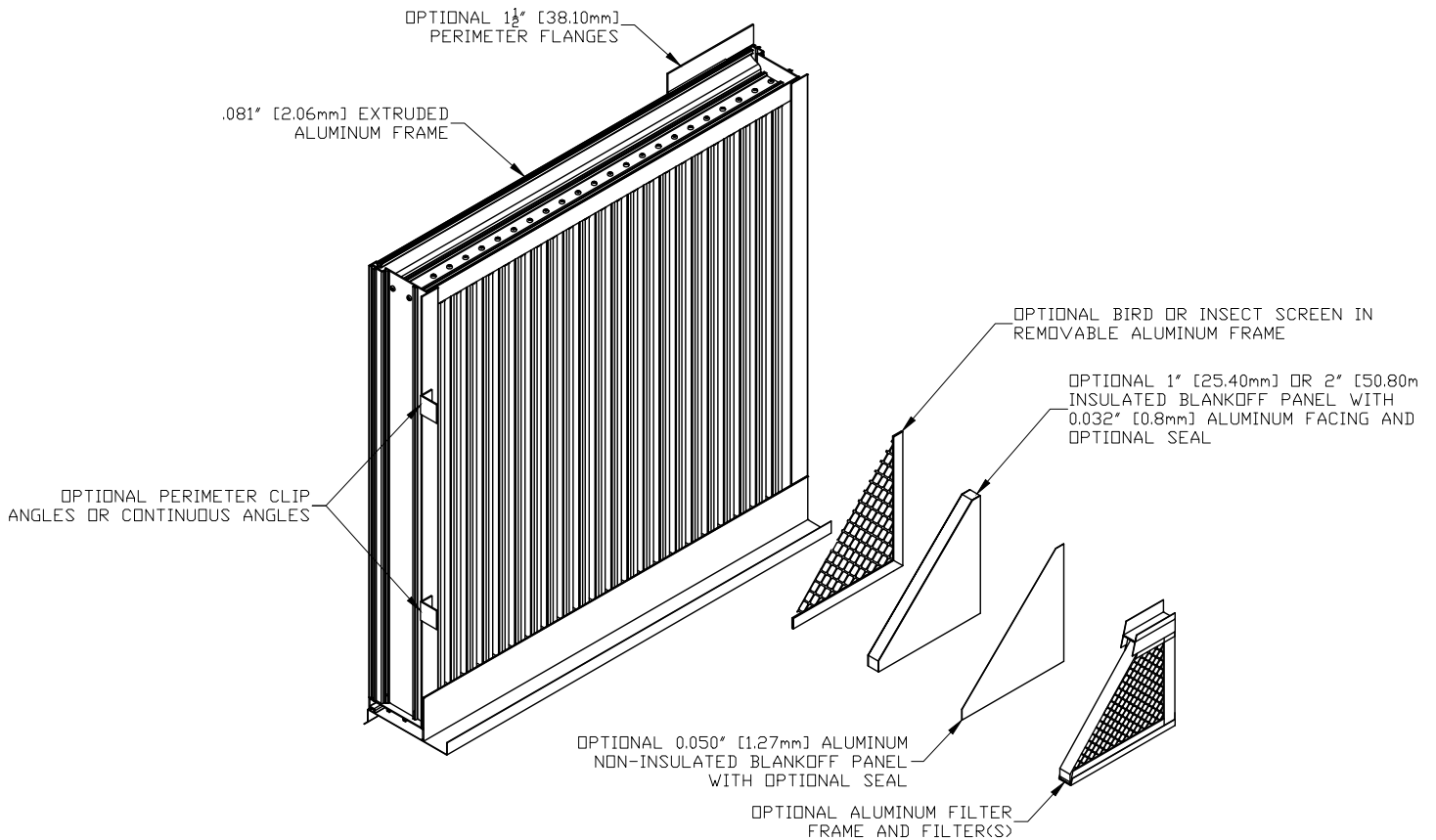

## FINISHES

| Finish Type   | Description/Application  | Color Selection  | Standard Warranty (Aluminum)                                      |
|---|--|--|---|
| <b>AAMA 2605</b><br>100% Fluoropolymer (FEVE)<br>2-Coat 70% Kynar® (PVDF)<br>3-Coat 70% Kynar® (PVDF)<br>4-Coat 70% Kynar® (PVDF) | <b>"Best."</b> The premier finish for extruded aluminum. Tough, long-lasting coating has superior color retention and abrasive properties. Resists chalking, fading, chemical abrasion and weathering. | <b>Standard Colors:</b><br>Any of the 27 standard colors shown can be furnished in 70% or 50% Kynar®, 100% Fluoropolymer or Baked Enamel.                            | 10 Years<br>(Consult Venco for availability of extended warranty) |
| <b>AAMA 2604</b><br>50% Kynar® / Acroflur®  | <b>"Better."</b> Tough, long-lasting coating has excellent color retention and abrasive properties. Resists chalking, fading, chemical abrasion and weathering.  | <b>Mica Colors:</b><br>Venco offers 6 standard Mica colors for 70% Kynar® or 100% Fluoropolymer.   | 5 Years   |
| <b>AAMA 2603</b><br>Baked Enamel  | <b>"Good."</b> Provides good adhesion and resistance to weathering, corrosion and chemical stain.  | <b>Custom Colors:</b><br>Custom color matching is available. Consult your Venco representative for cost and/or lead-time implications if a custom color is required. | 1 Year  |
| <b>AA-M10C22A42</b><br>Integral Color Anodize   | "Two-step" anodizing is produced by following the normal anodizing step with a second, colorfast process.  | Light, Medium, Dark or Extra Dark Bronze; Champagne; Black   | 5 years   |
| <b>AA-M10C22A41</b><br>Clear Anodize 215 R-1  | Clear, colorless and hard oxide aluminum coating that resists weathering and chemical attack.  | Clear  | 5 years   |
| <b>AA-M10C22A31</b><br>Clear Anodize 204  | Clear, colorless and hard oxide aluminum coating that resists weathering and chemical attack.  | Clear  | 1 Year  |
| <b>Prime Coat</b>   | Louvers or architectural products shall be cleaned, pre-treated and receive a prime coat finish suitable for field painting. Venco does not recommend prime coat or field painting of materials.       |  | n/a   |
| <b>Mill</b>   | Materials may be supplied in natural aluminum or galvanized steel finish when normal weathering is acceptable and there is no concern for color or color change.                                       |  | n/a   |

Finishes meet or exceed AAMA 2605, AAMA 2604, and AAMA 2603 requirements. Please consult Venco for complete information on standard and extended paint warranties. Paint finish warranties are not applicable to steel products.



VAVH-5  
February 2020  
Copyright © 2020 Venco

Venco reserves the right to make product changes without notice.