

Adjustable Louver Drainable Blade

Application and Design

VAAD-4 is an adjustable louver designed to protect air intake and exhaust openings in building exterior walls that require tight air shut off. Design incorporates a drainable head member and adjustable drainable blades to channel water to the jambs which guides the water through vertical downspouts for escape at the sill. The VAAD-4 is an extremely efficient louver tested in accordance with AMCA 500-L air performance and water penetration enabling designers to select and apply with confidence.

Standard Construction

- Frame** Heavy gauge extruded 6063-T5 aluminum, 4 in. x 0.125 in. nominal wall thickness
- Blades** Drainable design, heavy gauge extruded 6063-T5 aluminum, 0.081 in. nominal wall thickness, positioned at 45° angles on approximately 4 in. centers
- Seals** Dual-durometer extruded vinyl blade seals
Compressible stainless steel jamb seals
- Temperature Restrictions** . . . (-20° F) - (+180° F)
- Linkage** Side linkage, out of airstream (concealed in frame)
- Bearings** Synthetic sleeve type
- Axles** ½ in. dia. zinc plated steel
- Construction** . . . Mechanically fastened
- Birdscreen** 3/4 in. x 0.051 in. flattened expanded aluminum in removable frame, inside mount (rear)
- Finish** Mill
- Minimum Size** . . 12 in. W x 12 in. H
- Maximum Single Section Size** . . . 60 in. W x 96 in. H

Options (at additional cost)

- A variety of bird and insect screens
- A variety of electric, pneumatic or manual actuators
- Clip angles
- Extended sill
- Filter rack
- Flanged frame
- Glazing adaptor
- Security bars
- A variety of architectural finishes including:
 - Clear anodize
 - Integral color anodize
 - Baked enamel paint
 - Kynar paint

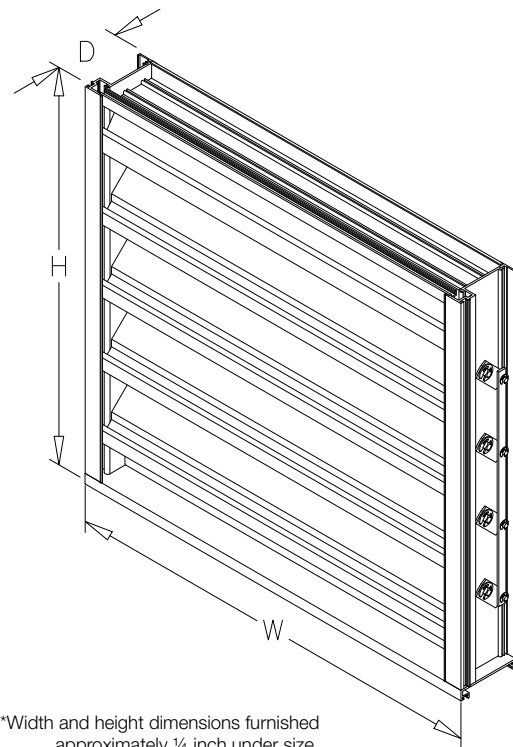
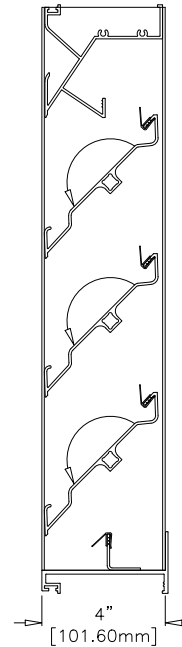

*Width and height dimensions furnished approximately ¼ inch under size.

PERFORMANCE DATA

VAAD-4

Aluminum Adjustable Louver
Drainable Blade

Free Area Chart (Sq. ft.)

Louver Height Inches	Louver Width in Inches								
	12	18	24	30	36	42	48	54	60
12	0.15	0.25	0.36	0.46	0.56	0.66	0.76	0.86	0.96
18	0.28	0.47	0.65	0.84	1.02	1.20	1.39	1.57	1.76
24	0.54	0.89	1.25	1.60	1.95	2.30	2.65	3.00	3.35
30	0.67	1.11	1.54	1.98	2.41	2.85	3.28	3.72	4.15
36	0.80	1.32	1.84	2.36	2.88	3.40	3.91	4.43	4.95
42	1.06	1.75	2.43	3.12	3.81	4.49	5.18	5.86	6.55
48	1.19	1.96	2.73	3.50	4.27	5.04	5.81	6.58	7.35
54	1.32	2.17	3.03	3.88	4.73	5.59	6.44	7.30	8.15
60	1.58	2.60	3.62	4.64	5.66	6.68	7.71	8.73	9.75
66	1.70	2.81	3.92	5.02	6.13	7.23	8.34	9.44	10.55
72	1.83	3.02	4.21	5.40	6.59	7.78	8.97	10.16	11.35
78	2.09	3.45	4.81	6.16	7.52	8.88	10.23	11.59	12.95
84	2.22	3.66	5.10	6.54	7.98	9.42	10.86	12.30	13.74
90	2.35	3.87	5.40	6.92	8.45	9.97	11.50	13.02	14.54
96	2.61	4.30	5.99	7.68	9.38	11.07	12.76	14.45	16.14

Air Leakage (with damper section closed) Test size 48 in. x 48 in.

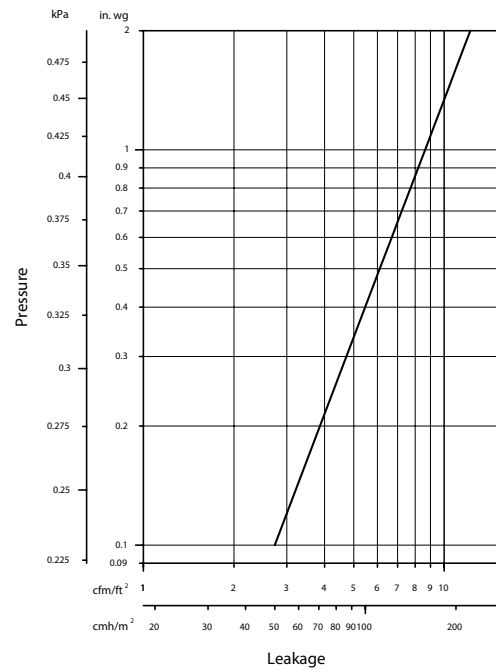

Airflow Resistance (Standard Air - .075 lb/ft³)

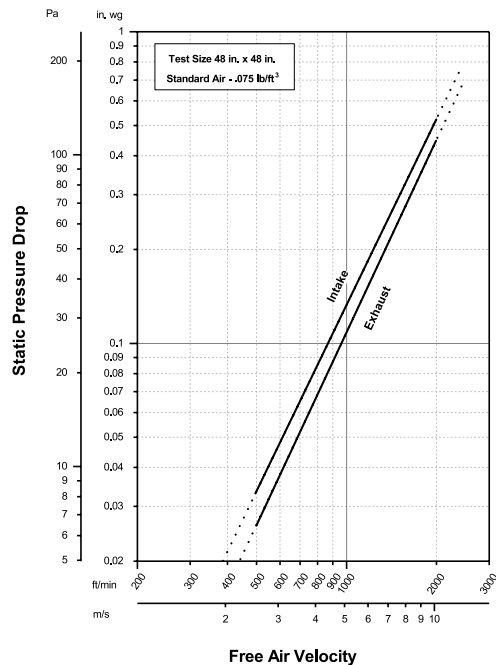

Model VAAD-4 resistance to airflow (pressure drop) varies depending on louver application (air intake or air exhaust). Free area velocities (shown) are higher than average velocity through the overall louver size. See louver selection information.

Water Penetration (Standard Air - .075 lb/ft³) Test size 48 in. x 48 in. Test duration of 15 min.

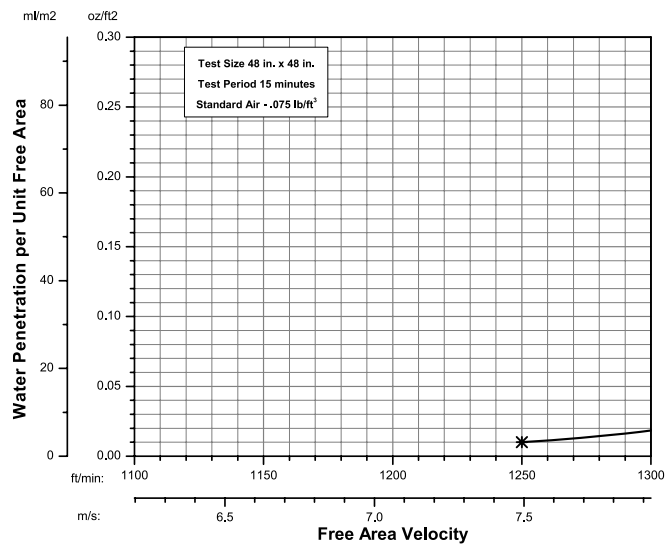

The AMCA Water Penetration Test provides a method for comparing various louver models and designs as to their efficiency in resisting the penetration of rainfall under specific laboratory test conditions. The beginning point of water penetration is defined as that velocity where the water penetration curve projects through .01 oz. of water (penetration) per sq. ft. of louver free area. ***The beginning point of water penetration for Model VAAD-4 is 1250 fpm (6.35 m/s) free area velocity.** These performance ratings do not guarantee a louver to be weatherproof or stormproof and should be used in combination with other factors including good engineering judgement in selecting louvers.

INSTALLATION DETAILS

VAAD-4

Maximum Size and Installation Information

Aluminum Adjustable Louver
Drainable Blade

Maximum single section size for model VAAD-4 is 60 in. W x 96 in. H. Larger openings require field assembly of multiple louver sections to make up the overall opening size. Individual louver sections are designed to withstand a 25 PSF wind load (please consult Venco if the louvers must withstand higher wind-loads). Structural reinforcing members may be required to adequately support and install multiple louver sections within a large opening. Structural reinforcing members along with any associated installation hardware is not provided by Venco unless indicated otherwise by Venco. Options and accessories including, but not limited to, screens, filter racks, louver doors, and blankoff panels are not subject to structural analysis unless indicated otherwise by Venco.

SINGLE SECTION

MULTIPLE SECTION W/ MULLION

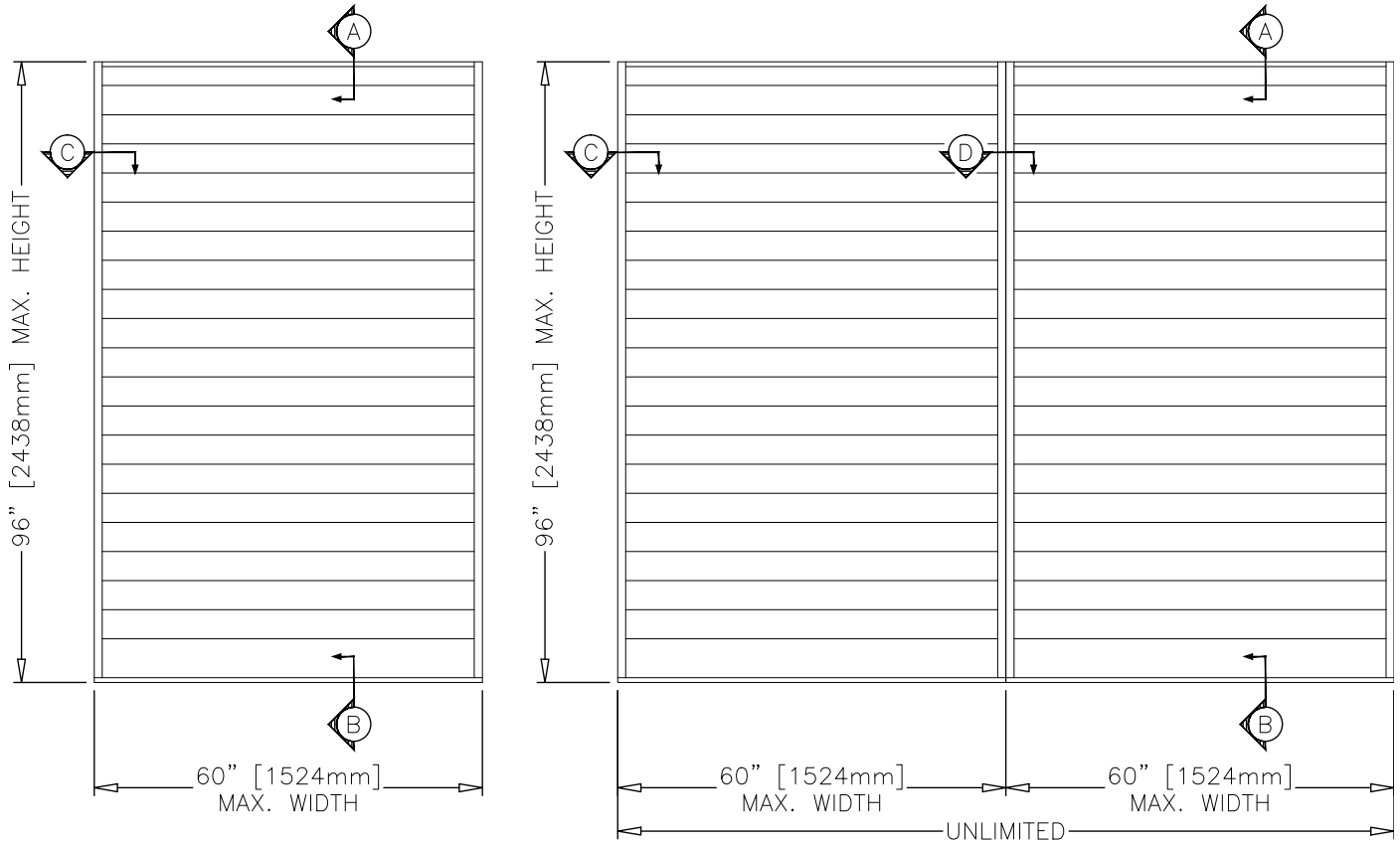

Minimum Single Section Size

12 in. W x 12 in. H

Maximum Single Section Size

60 in. W x 96 in. H

PRODUCT DETAILS

VAAD-4

Aluminum Adjustable Louver
Drainable Blade

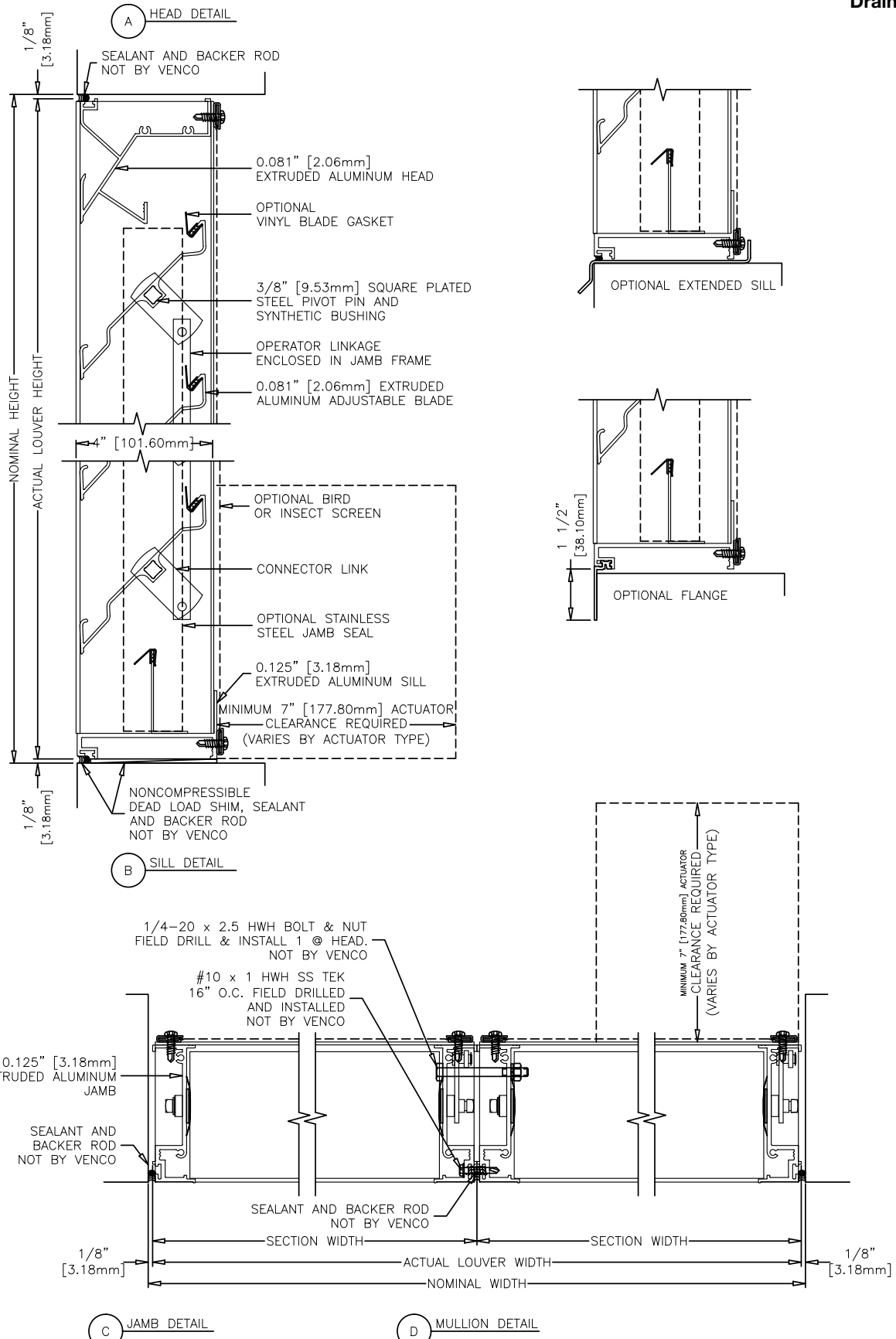

OPTION DRAWINGS

VAAD-4

Aluminum Adjustable Louver Drainable Blade

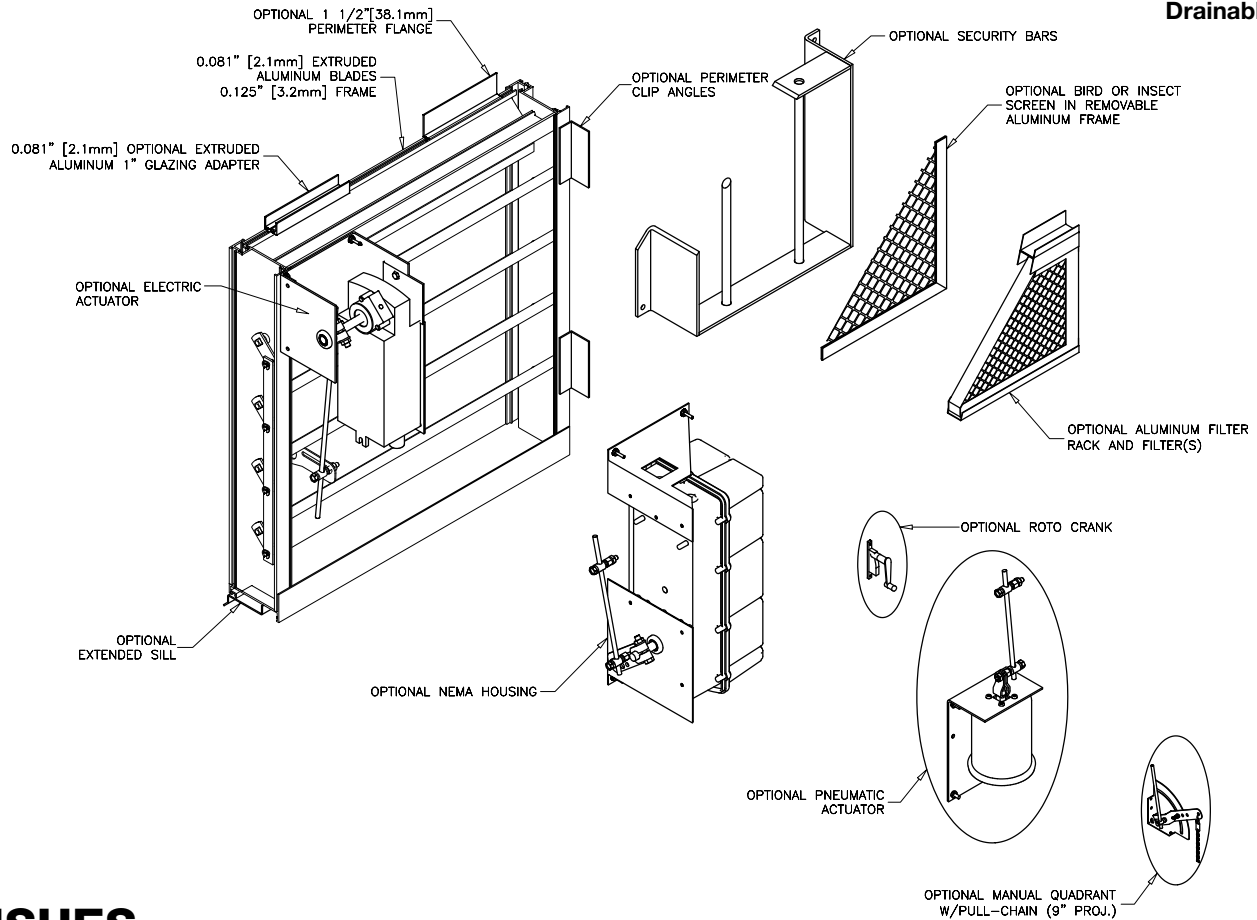

FINISHES

Finish Type	Description/Application	Color Selection	Standard Warranty (Aluminum)
AAMA 2605 100% Fluoropolymer (FEVE) 2-Coat 70% Kynar® (PVDF) 3-Coat 70% Kynar® (PVDF) 4-Coat 70% Kynar® (PVDF)	"Best." The premier finish for extruded aluminum. Tough, long-lasting coating has superior color retention and abrasive properties. Resists chalking, fading, chemical abrasion and weathering.	Standard Colors: Any of the 27 standard colors shown can be furnished in 70% or 50% Kynar®, 100% Fluoropolymer or Baked Enamel.	10 Years (Consult Venco for availability of extended warranty)
AAMA 2604 50% Kynar® / Acroflur®	"Better." Tough, long-lasting coating has excellent color retention and abrasive properties. Resists chalking, fading, chemical abrasion and weathering.	Mica Colors: Venco offers 6 standard Mica colors for 70% Kynar® or 100% Fluoropolymer.	5 Years
AAMA 2603 Baked Enamel	"Good." Provides good adhesion and resistance to weathering, corrosion and chemical stain.	Custom Colors: Custom color matching is available. Consult your Venco representative for cost and/or lead-time implications if a custom color is required.	1 Year
AA-M10C22A42 Integral Color Anodize	"Two-step" anodizing is produced by following the normal anodizing step with a second, colorfast process.	Light, Medium, Dark or Extra Dark Bronze; Champagne; Black	5 years
AA-M10C22A41 Clear Anodize 215 R-1	Clear, colorless and hard oxide aluminum coating that resists weathering and chemical attack.	Clear	5 years
AA-M10C22A31 Clear Anodize 204	Clear, colorless and hard oxide aluminum coating that resists weathering and chemical attack.	Clear	1 Year
Prime Coat	Louvers or architectural products shall be cleaned, pre-treated and receive a prime coat finish suitable for field painting. Venco does not recommend prime coat or field painting of materials.		n/a
Mill	Materials may be supplied in natural aluminum or galvanized steel finish when normal weathering is acceptable and there is no concern for color or color change.		n/a

Finishes meet or exceed AAMA 2605, AAMA 2604, and AAMA 2603 requirements. Please consult Venco for complete information on standard and extended paint warranties. Paint finish warranties are not applicable to steel products.



VAAD-4
February 2020
Copyright © 2020 Venco

Venco reserves the right to make product changes without notice.