

Application and Design

Model HCDR-150 is a heavy duty round industrial control damper with a flanged style frame. It is designed to control airflow and provide shut off in HVAC or industrial process control systems. A variety of optional features makes model HCDR-150 extremely versatile, allowing its capabilities to be tailored to the application.

Ratings (See pages 2 and 3 for specific limitations)

Pressure: Up to 6 in. wg (1.5 kPa) - differential pressure
Velocity: Up to 4000 fpm (20.3 m/s)
Temperature: -40 to 400°F (-40 to 204°C) Maximum

	Standard	Optional
Frame Material	Painted	304SS or 316SS
Frame Type	Flanged Channel	
Blade Material	Painted	304SS or 316SS
Blade Seals	None	EPDM, Silicone
Blade Stop	Pin Stop	Rolled Bar
Blade Type	Round Butterfly	
Axle Bearing	Stainless steel sleeve	External Bronze
Axle Material	Plated Steel	303SS or 316SS
Axle Seals	None	O-ring
Paint Finishes	Hi Pro Polyester	Hi Temperature Flame Control, Hi Temperature Silver, Industrial Epoxy, None

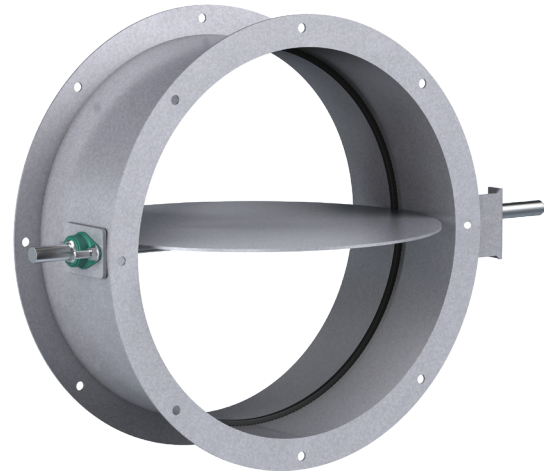

Diameter = Actual Inside Dimension

<i>Diameter</i>	<i>Minimum Size</i>	<i>Maximum Size</i>
Inches	4	48
mm	102	1219

Features

- Wide mounting flanges can be ordered with bolt holes, customized to match your requirements.
- Rolled bar stops are required when blade seal is selected.
- Wide range of actuators available.

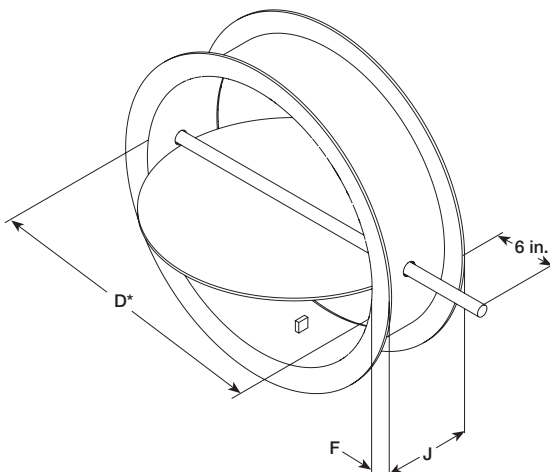

Diameter <i>D</i> Inches (mm)		Frame Depth <i>J</i> Inches (mm)	Frame & Flange Gauge (mm)	Flange Width <i>F</i> Inches (mm)	Axle Diameter Inches (mm)	Blade Thickness Gauge (mm)
Above	Through					
3.99 (101)	12 (305)	6 (152)	12 (2.7)	1.25 (32)	0.5 (13)	10 (3.5)
12 (305)	20 (508)	8 (203)	12 (2.7)	1.5 (32)	0.5 (13)	10 (3.5)
20 (508)	24 (610)	8 (203)	12 (2.7)	1.5 (32)	0.75 (19)	10 (3.5)
24 (610)	36 (914)	8 (203)	10 (3.5)	2.0 (51)	.75 (19)	10 (3.5)
36 (914)	48 (1219)	8 (203)	10 (3.5)	2.0 (51)	1.00 (25)	10 (3.5)

Bearing and Shaft Options

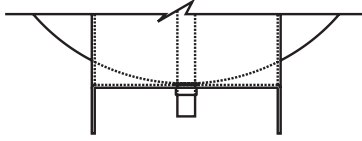

Stainless Steel Sleeve Bearing (Standard)

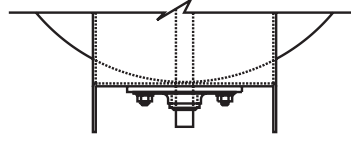

External Mounted Bronze Sleeve Bearing (Optional)

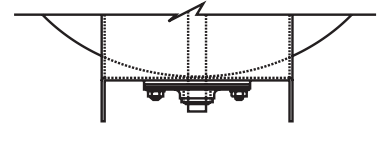

External Mounted Bronze Sleeve Bearing with O-Ring (Optional)

Blade Seal Options (Rolled Bar Blade Stops Required)

Standard - Does not include Blade Seals

Optional - EPDM Blade Seals (250°F [121°C] max.)

Optional - Silicone Rubber Blade Seals (400°F [204°C] max.)

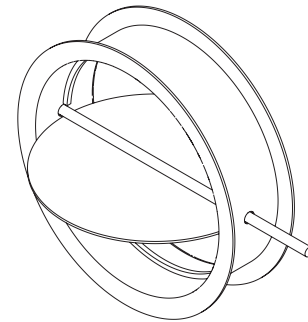

Rolled Bar Blade Stops

Bolt Holes

The recommended bolt hole pattern is shown in the table below. Customer must specify bolt holes that are parallel to the axle centerline or that straddle the axle centerline as shown in the diagrams below. The factory can also provide bolt hole sizes and patterns other than those shown.

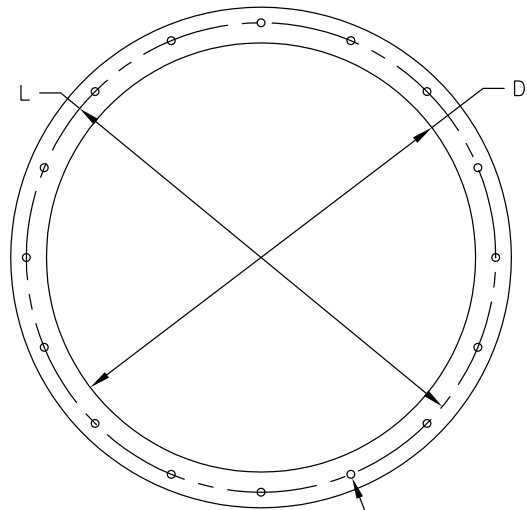

(N) ϕ M HOLES
ON ϕ L BOLT HOLE DIA.

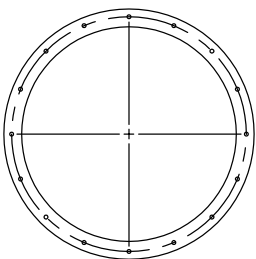

On Centerline

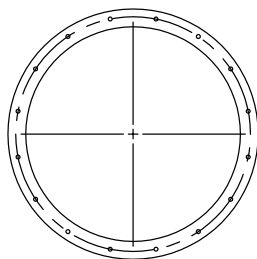

Straddle Centerline

Recommended Bolt Hole Pattern (Bolt Holes Parallel to Axle Centerline)					
Diameter Inches (mm)		Number of Holes	Mounting Hole Diameter in. (mm) N	Bolt Circle Diameter L	Degrees Between Holes
Above	Through				
4 (102)	8 (203)	4	3/8 (9.5)	*	90
8.001 (203)	18 (457)	8	7/16 (11)	*	45
18.001 (457)	24 (610)	12	7/16 (11)	*	30
24.001 (610)	36 (914)	16	7/16 (11)	*	22 1/2
36.001 (914)	58 (1473)	24	7/16 (11)	*	15
58.001 (1473)	72 (1829)	32	9/16 (14)	*	11 1/4

* Bolt Circle Diameter = Damper Diameter + Flange Height + 1/4 in. (6mm)

AMCA Test Figure 5.3

Figure 5.3 Illustrates a fully ducted damper. This configuration has low pressure drop because entrance and exit losses are minimized by straight duct runs upstream and downstream of the damper.

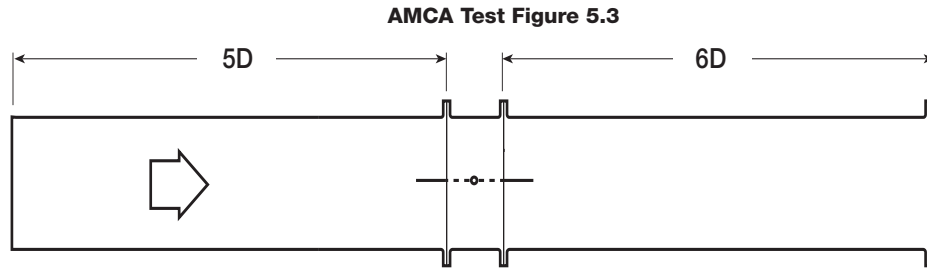

Pressure Drop Data

This pressure drop data was conducted in accordance with AMCA Standard 500-D using Test Figure 5.3. All data has been corrected to represent standard air at a density of 0.075 lb/ft³ (1.2 kg/m³).

Actual pressure drop found in any HVAC system is a combination of many factors. This pressure drop information along with an analysis of other system influences should be used to estimate actual pressure losses for a damper installed in a given HVAC system.

NOTE: PS refers to damper with standard pin blade stop

BS refers to damper with rolled bar blade stop

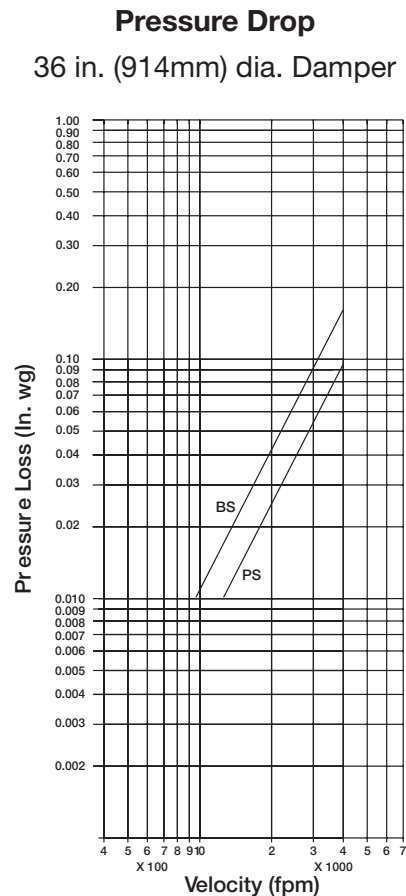
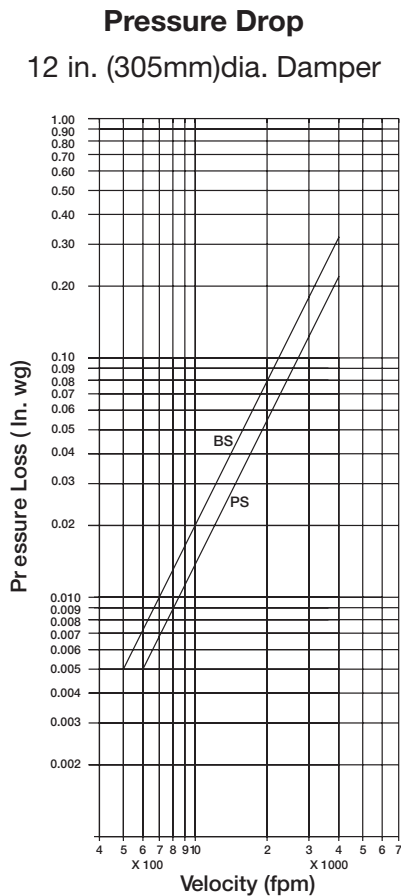

Leakage Data

Damper leakage (with blades fully closed) varies based on the type of blade stops and low leakage seals applied. Model HCDR-150 is available with no seals (standard) or with EPDM or silicone rubber blade seals. Leakage testing was conducted in accordance with AMCA Standard 500-D and is expressed as cfm/ft^2 of damper face area. All data has been corrected to represent standard air at a density of $0.075 \text{ lb}/\text{ft}^3$ ($1.2 \text{ kg}/\text{m}^3$).

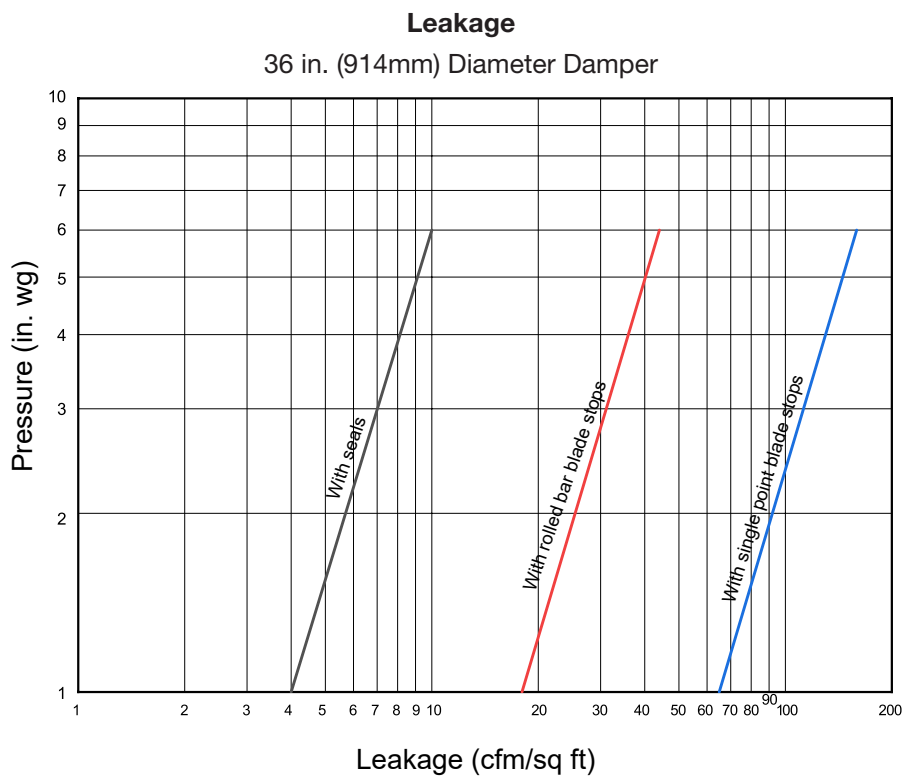
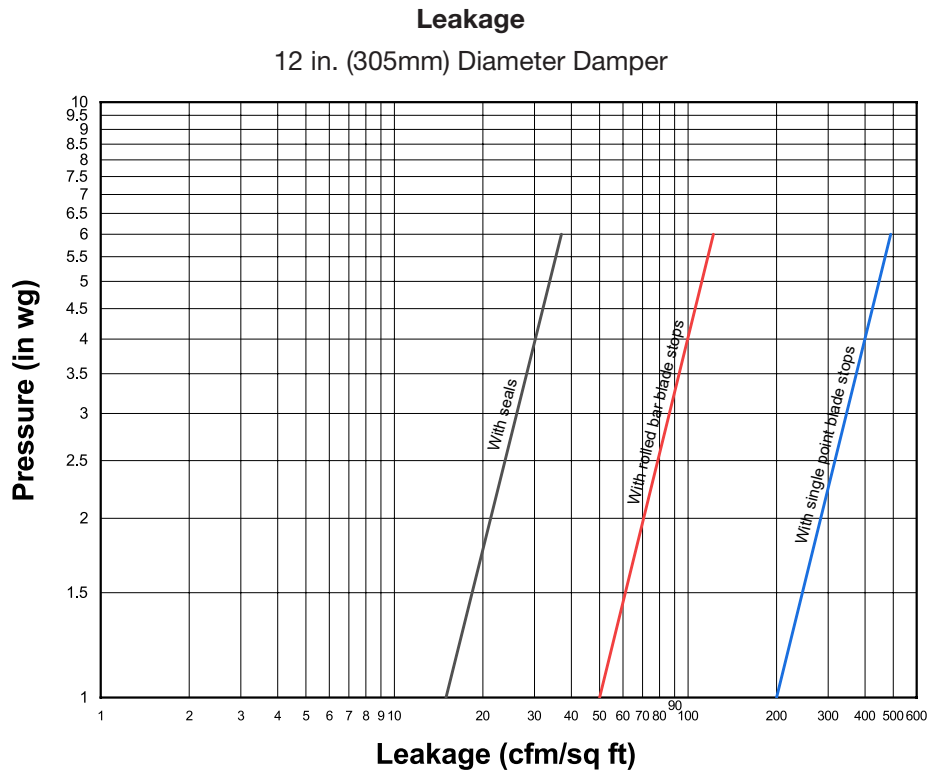

Specifications

Industrial grade control dampers meeting the following specifications shall be furnished and installed where shown on plans and/or as described in schedules.

Dampers shall consist of a round channel frame, single axle, and single circular blade fabricated from steel with Hi Pro Polyester finish. Damper axle shall be continuous pivoting in stainless steel sleeve bearings pressed into each side of the damper frame.

Damper manufacturer's printed application and performance data including pressure, velocity and temperature limitations shall be submitted for approval showing damper suitable for pressures to 6 in. wg (1.5 kPa), velocities to 4000 fpm (20.3 m/s) and temperatures to 400°F (204°C). Testing and ratings to be in accordance with AMCA Standard 500-D.

Specifier may add the following:

Dampers shall be equipped with blade seals for low leakage performance. Blade seals shall be: EPDM synthetic rubber for 250°F (121°C) maximum temperature, or Silicone Rubber for 400°F (204°C) maximum temperature. Testing and ratings shall be per AMCA Standard 500-D.

Basis of design is model HCDR-150.