

Application

Model HCD-130LE is a heavy duty flanged frame style industrial control damper with fabricated airfoil blades. It is designed to control airflow and provide shutoff in Vektor Lab Exhaust systems. This model is available with parallel or opposed blade action.

Ratings

Pressure*

Up to 8.5 in. wg (2.1 kPa) - differential pressure

Velocity*

Up to 4000 fpm (20.3 m/s)

Temperature*

-40 to 400°F (-40 to 204°C). Temperatures over 250°F (121°C) require special blade end clearance. For higher temperatures, consult factory.

* See page 4 for specific limitations.

Construction

	Standard	Optional
Frame Depth (C)	8 in. (203mm)	10 in. (254mm)
Frame Material	Galvanized Steel	304SS, 316SS
Frame Type	Flanged Channel	
Frame Thickness	14 ga. (2mm)	10 ga. (3.5mm) 12 ga. (2.7mm)
Flange Width (D)	2 in. (51mm)	1½ in. (38mm) 2½ in. (64mm) 3 in. (76mm)
Blade Action	Parallel	Opposed
Blade Material	Galvanized Steel	304SS, 316SS
Blade Seals	None	EPDM, Silicone
Blade Thickness	20 ga. (1mm) Double Skin	-
Blade Type	Fabricated Airfoil	
Linkage	Plated Steel	304SS, 316SS
Jamb Seals	None	301SS, 316SS
Axle Diameter	½ in. (12.7mm)	-
Axle Bearing	Stainless Steel Sleeve	-
Axle Material	Plated Steel	316SS
Axle Seals	None	-
Paint Finishes	None	Hi Pro Polyester, Hi Temperature Silver, Industrial Epoxy
Mounting Holes	None	Standard; Standard with corner holes



Optional actuator shown.

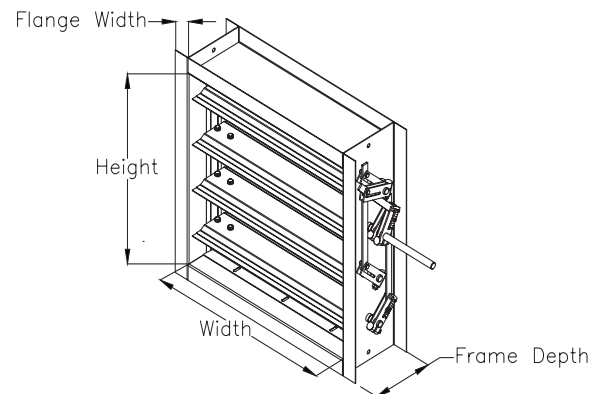

* Actual Inside Dimension. The W dimension is ALWAYS parallel with the damper blade length.

Damper linkage and axles may extend beyond the damper flange based on the configuration of selectable options. Consult factory for dimensions.

Size Limitations

WxH	Minimum Size	Maximum Size	
		Single Section	Multi-Section
Inches	6½ x 5	60 x 96	120 x 96
mm	165 x 127	1524 x 2438	3048 x 2438

Features:

- Wide range of actuators available

Options:

- Vertical Blade Orientation

Pressure Drop

This pressure drop data was conducted in accordance with AMCA Standard 500-D using the three configurations shown. All data has been corrected to represent standard air at a density of .075 lb/ft³ (1.2 kg/m³).

Actual pressure drop found in any HVAC system is a combination of many factors. This pressure drop information along with an analysis of other system influences should be used to estimate actual pressure losses for a damper installed in a given HVAC system.

AMCA Test Figures

Figure 5.3 illustrates a fully ducted damper. This configuration has the lowest pressure drop of the three test configurations because the entrance and exit losses are minimized by straight duct runs upstream and downstream of the damper.

Figure 5.2 illustrates a ducted damper exhausting air into an open area. This configuration has a lower pressure drop than Figure 5.5 because the entrance losses are minimized by a straight duct run upstream of the damper.

Figure 5.5 illustrates a plenum mounted damper. This configuration has the highest pressure drop because of the high entrance and exit losses due to the sudden changes of area in the system.

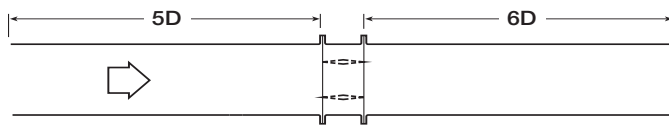

Fig. 5.3

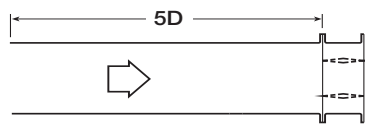

Fig. 5.2

$$D = \sqrt{\frac{4(W)(H)}{3.14}}$$

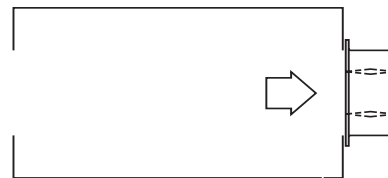
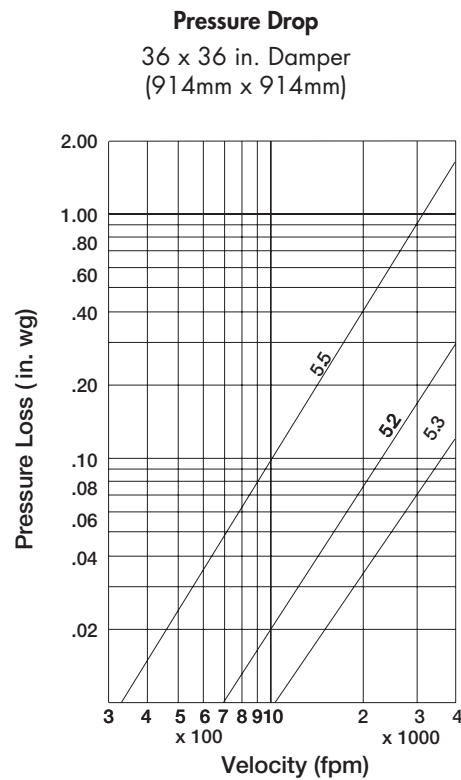
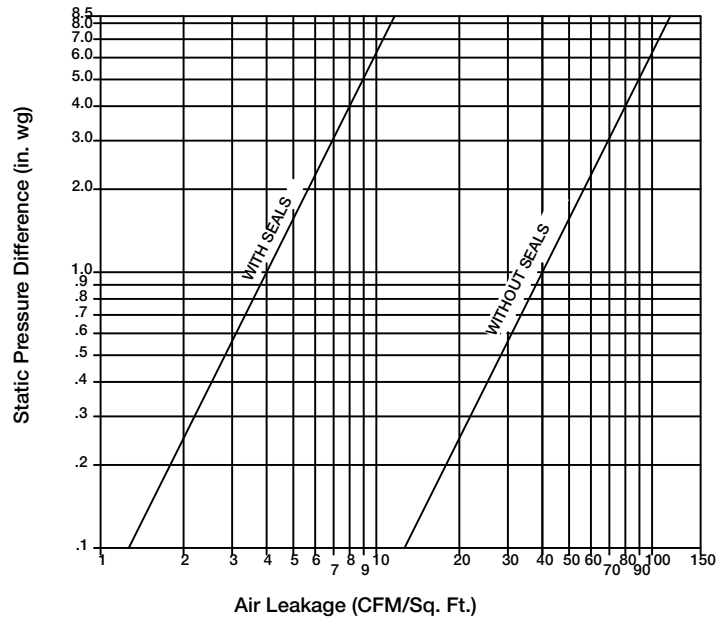

Fig. 5.5



Damper leakage (with blades fully closed) varies based on the type of low leakage seals applied. Model HCD-130LE is available with no jamb seals (standard) or with stainless steel jamb seals and EPDM, or silicone rubber blade seals. Leakage testing was conducted in accordance with AMCA Standard 500-D and is expressed as CFM per sq. ft. of damper face area. All data has been corrected to represent standard air at a density of .075 lb/ft³ (1.2 kg/m³).

Leakage
 36 x 36 in. (914mm x 914mm) Damper
 (based on 5 in. lb/ft² of torque)



Limitations

Pressure Limitations

The chart at the right shows conservative pressure limitations based on a maximum blade deflection of $w/360$.

Temperature Limitations

Blade seals: Silicone -40° to 400°F (-40° to 204°C)
EPDM -20° to 250°F (-29° to 121°C)

Jamb seals: Flexible stainless steel -40° to 400°F
(-40° to 204°C)

For higher temperatures, consult factory.

Velocity Limitations

The chart at far right shows velocity limitations based on damper size.

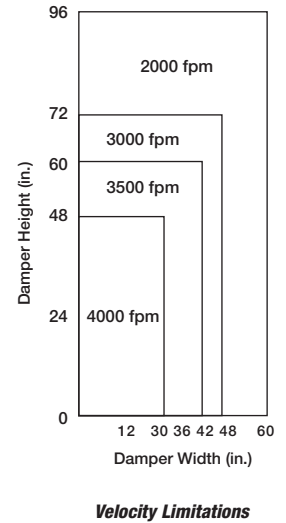
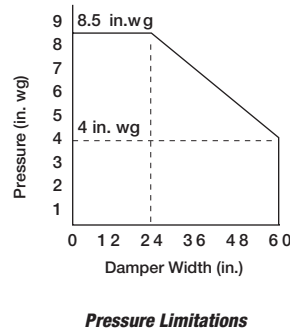

Document Links

[Installation Instructions](#)



[Industrial Damper Catalog](#)



[Damper Warranty Statement](#)



Specifications

Industrial grade control dampers meeting the following specifications shall be furnished and installed where shown on plans and/or as described in schedules.

Dampers shall consist of: a 14 ga. (2mm) galvanized steel channel frame with 8 in. (203mm) minimum depth and 2 in. (51mm) flanges; double skin airfoil type blades fabricated from two layers of 20 ga. (1mm) galvanized steel; ½ in. (12.7mm) dia. plated steel axles turning in stainless steel sleeve bearings; and external (out of the airstream) blade-to-blade linkage.

Damper manufacturer's printed application and performance data including pressure, velocity, and temperature limitations shall be submitted for approval showing damper suitable for pressures to 8.5 in. wg (2.1 kPa), velocities to 4,000 fpm (20.3 m/s) and temperatures to 400°F (204°C).

Specifier may add the following:

Damper shall be equipped with blade and jamb seals for low leakage performance. Blade seals shall be EPDM 250°F (121°C) maximum temperature or Silicone rubber for 400°F (204°C) maximum temperature. Jamb seals shall be flexible stainless steel. Testing and ratings shall be per AMCA Standard 500-D.

Basis of design is model HCD-130.

