



HB-110

Industrial Backdraft Damper

Aluminum Construction

Corrosion Resistant

Spark 'B' and 'C' Resistant

Application and Design

Model HB-110 is a heavy duty backdraft damper with a double flanged galvanized steel channel frame and extruded aluminum blades. It is designed to prevent backflow and to provide shutoff in HVAC or industrial process systems. External heavy duty linkage, blade counterbalance, and ball bearings are standard.

Ratings

Pressure: Up to 5.0 in. wg (1.2 kPa) - differential pressure

Velocity: Up to 3900 fpm (19.8m/s)

Temperature: -20°F to 180°F (-29°C to 82°C)

Construction

	Standard	Optional
Frame Material	Galvanized Steel	Aluminum, 304SS or 316SS
Frame Type	Flanged Channel	
Frame Gauge	14 ga. (2mm)	.125 in. (3mm)
Frame Depth	8 in.(203mm)	8 in. - 12 in. (203mm - 305mm)
Blade Material	Aluminum	-
Blade Type	Extruded Single Thickness	
Blade Gauge	.070 in. (1.8mm)	-
Blade Seals	Vinyl	None
Flanges	2 in. (51mm)	1 1/2 in. (38mm)
Axle Bearing	Galvanized Ball	Acetal with SS Ball
Axle Diameter	3/8 in. (9.5mm) square	-
Axle Material	Plated Steel	316SS
Linkage	External heavy duty type with steel clevis arms and plated steel tie bars & pivot pins with nylon pivot bearings	304SS or 316SS
Air Flow	-	Horizontal, Vertical Up, Vertical Down, Angular Up, Angular Down
Paint Finishes	Mill Finish	Epoxy, Hi Pro Polyester, Industrial Epoxy
Mounting Holes	None	Standard, Standard w/Corner Holes



RH

LH

* Actual inside dimension.

** The W dimension is ALWAYS parallel with the damper blade length.

*** RH counterbalance is standard.

**** Counterbalance weights extend beyond inlet flange in the open position.

Counterbalance Weight Dimensions

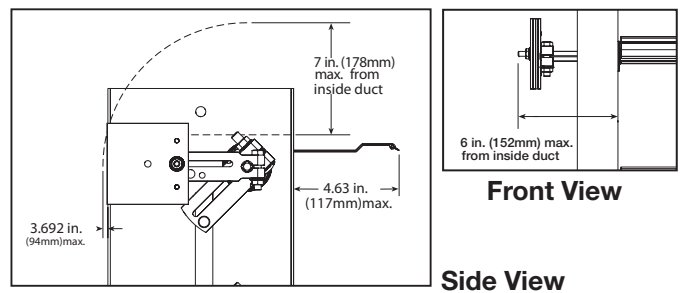

Advise air flow direction & counterbalance weight location when ordering

Size Limitations

W x H	Minimum Size	Maximum Size	
		Single Section	Multi - Section
Inches	6 x 6	48 x 96	96 x 96
mm	152 x 152	1219 x 2438	2438 x 2438

Pressure Limitations

The chart at the right shows conservative pressure limitations based on a maximum blade deflection of w/360.

Temperature Limitations

Blade seals: Vinyl -20° to 180°F (-29° to 82°C)

For higher temperatures, consult factory.

Velocity Limitations

The chart at far right shows velocity limitations based on damper size.

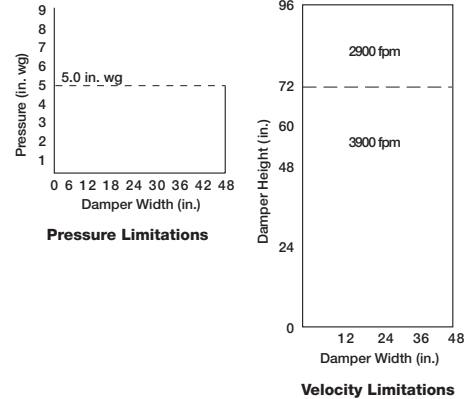

Pressure Drop Data

This pressure drop data was conducted in accordance with AMCA Standard 500-D using the three configurations shown. All data has been corrected to represent standard air at a density of .075 lb/ft³ (1.2 kg/m³).

Actual pressure drop found in any HVAC system is a combination of many factors. This pressure drop information along with an analysis of other system influences should be used to estimate actual pressure losses for a damper installed in a given HVAC system.

AMCA Test Figures

Figure 5.3 illustrates a fully ducted damper. This configuration has the lowest pressure drop of the three test configurations because the entrance and exit losses are minimized by straight duct runs upstream and downstream of the damper.

Figure 5.2 illustrates a ducted damper exhausting air into an open area. This configuration has a lower pressure drop than Figure 5.5 because the entrance losses are minimized by a straight duct run upstream of the damper.

Figure 5.5 illustrates a plenum mounted damper. This configuration has the highest pressure drop because of the high entrance and exit losses due to the sudden changes of area in the system.

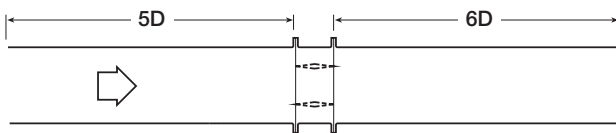

Fig. 5.3

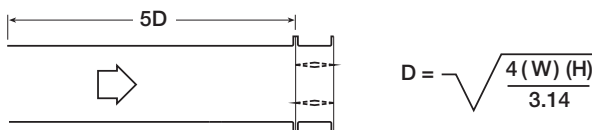

Fig. 5.2

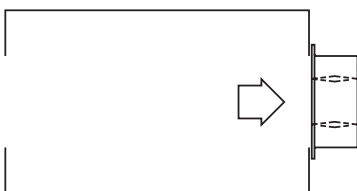
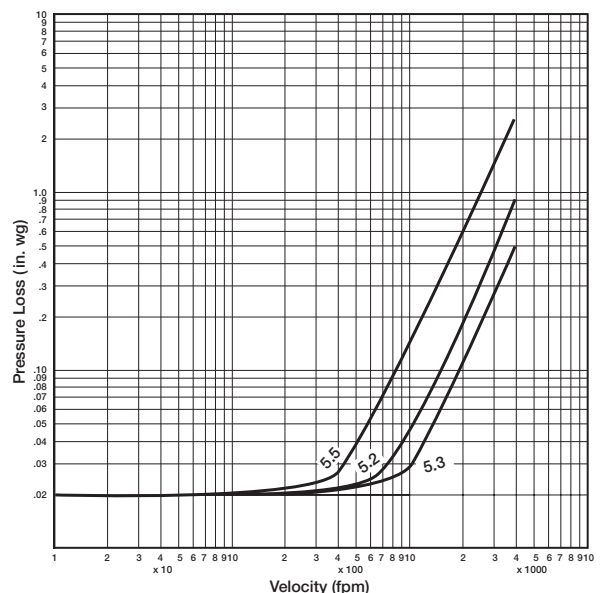

Fig. 5.5

Pressure Drop

36 in. x 36 in. (914mm x 914mm) Damper



Leakage Data

Leakage testing was conducted in accordance with AMCA Standard 500-D and is expressed as CFM per sq. ft. of damper face area. All data has been corrected to represent standard air at a density of 0.075 lb/ft³ (1.2 kg/m³).

Leakage

36 in. x 36 in. (914mm x 914mm) Damper

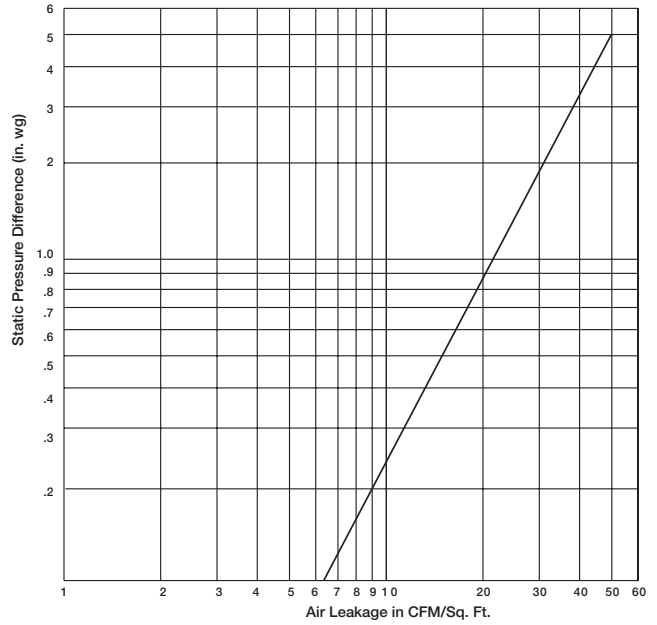

Bolt holes are available as an option. The standard pattern is 7/16 in. (11mm) diameter holes (M dimension) spaced 6 in. (152mm) on center (L dimension). Custom bolt hole patterns are available. Contact factory for the limitations.

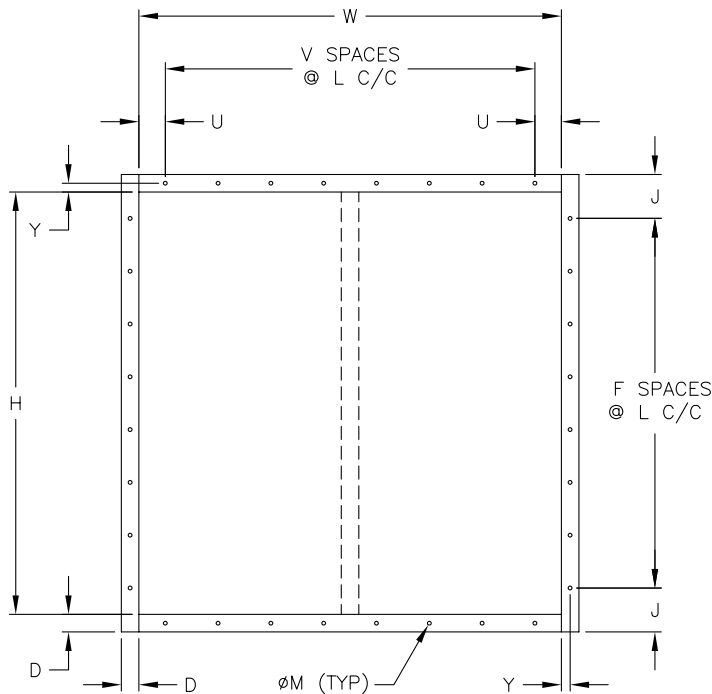

Standard Mounting Hole Pattern
Typical for single or double wide panel

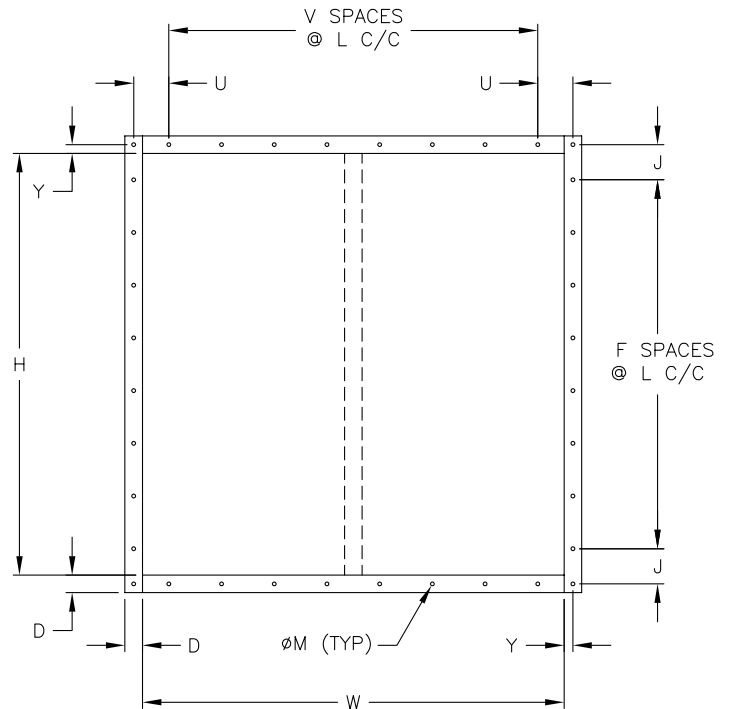

Standard Mounting Hole Pattern with Corner Holes
Typical for single or double wide panel

Multiple Section Assembly

Damper sizes larger than 48 in. x 96 in. (1219mm x 2438mm) and less than 96 in. x 96 in. (2438mm x 2438mm) will be supplied in one frame with two sets of blades separated by a mullion as shown below. Counterbalance weights supplied on right hand and left hand side. For sizes larger than 96 in. x 96 in. (2438mm x 2438mm), consult factory.

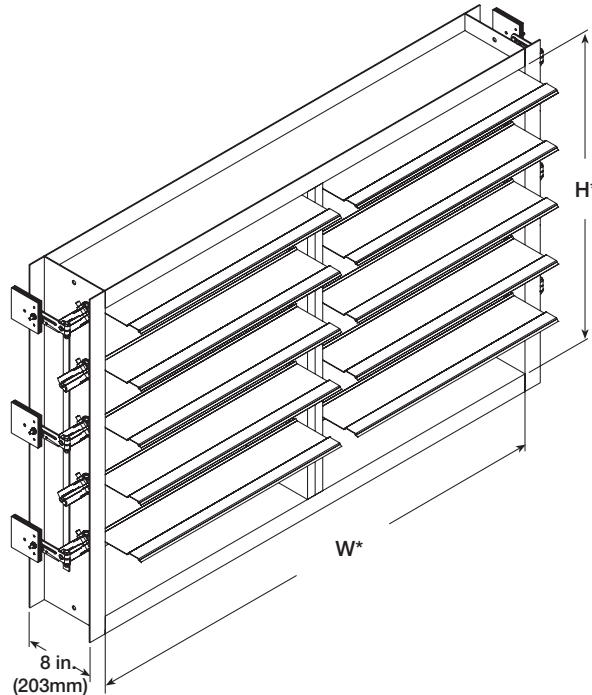

Specifications

Industrial grade backdraft dampers meeting the following specifications shall be furnished and installed where shown on plans and/or as described in schedules.

Dampers shall consist of: a 14 ga. (2mm) galvanized steel channel frame with 8 in. (203mm) minimum depth and 2 in. (51mm) flanges; 0.070 in. (1.8mm) thick 6063T5 extruded aluminum blades; 3/8 in. (9.5mm) dia. type galvanized steel ball bearings press fit into frame; and external (out of the

airstream) heavy duty linkage with counterbalance weights.

Damper manufacturer's printed application and performance shall be submitted for approval showing damper suitable for pressures to 5 in. wg (1.2 kPa), velocities to 3900 fpm (19.8m/s) and temperatures to 180°F (82°C). Testing and ratings to be in accordance with AMCA Standard 500-D.

Basis of design is model HB-110.