

## Installation, Operation and Maintenance Manual

Please read and save these instructions for future reference. Read carefully before attempting to assemble, install, operate or maintain the product described. Protect yourself and others by observing all safety information. Failure to comply with these instructions will result in voiding of the product warranty and may result in personal injury and/or property damage.

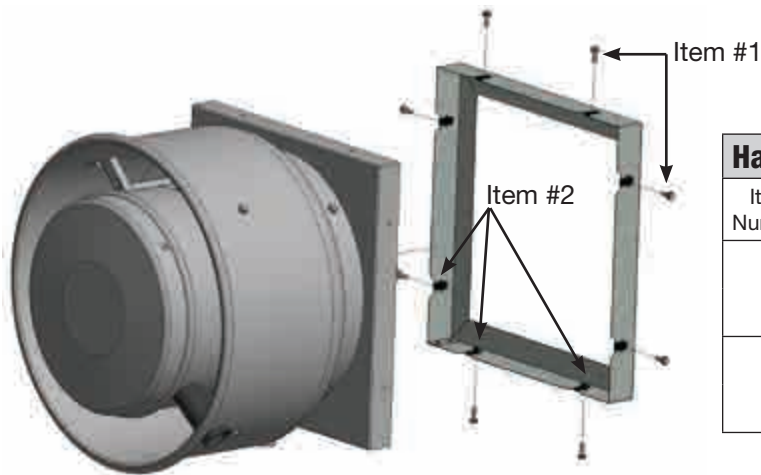

Hardware List				
Item Number	Qty.	Fan Size	Description	Part Number
1	8	060-200	1/4 - 20 x 0.75" L Hex Bolt, Stainless Steel	415573
	14	220-300		
2	8	060-200	1/4 - 20 U Style Spring Nut, Black Phosphate Coated Steel	415244
	14	220-300		

### Recommendations for Installation

Wall brackets have pre-punched 5/16 inch holes for mounting the bracket to the wall. Hole diameter may need to be increased depending on the anchor fasteners chosen by the installer. Quantity of fan-to-wall bracket fasteners vary by wall bracket size. Refer to 'Included Hardware' table above.

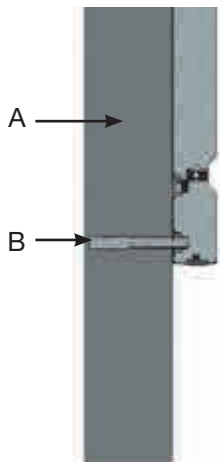

#### Concrete Anchoring

- A. Concrete - 4 inch minimum wall thickness. Minimum of 2,500 psi.
- B. Expansion Wedge Anchors
  - Min. of 3/8 inch diameter
  - Min. of 2 inch engagement
  - Use a washer under each nut

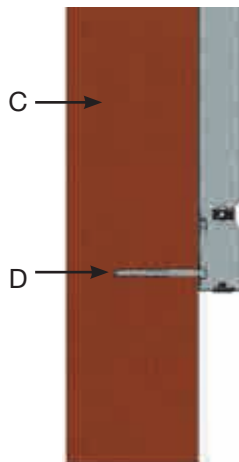

#### Timber Anchoring

- C. Wood Timber - minimum nominal thickness of 4 inch.
- D. Lag Bolt
  - Min. of 5/16 inch diameter
  - Min. 2 inch of thread engagement
  - Use a washer under each bolt head

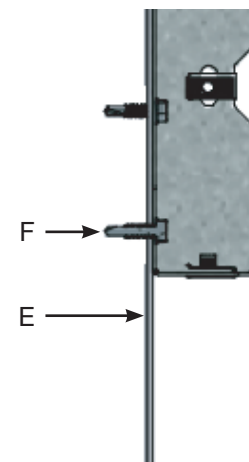

#### Steel Anchoring

- E. Structural Steel
  - 1/8 inch thick or 12 ga min.
- F. Self-Drilling Screw
  - Min. size of #12
  - Min. 1/2 inch of thread hangout
  - Use a washer under each screw head.

Wall Opening Size		
Unit Size	Fan Curb Cap Size (in.)	Maximum Wall Opening - X (in.)
060-070	17	12.5
080-131	19	14.5
141-161	22	17.5
141-161	26	21.5
180-200	30	25.5
220-240	34	29.5
300	40	35.5

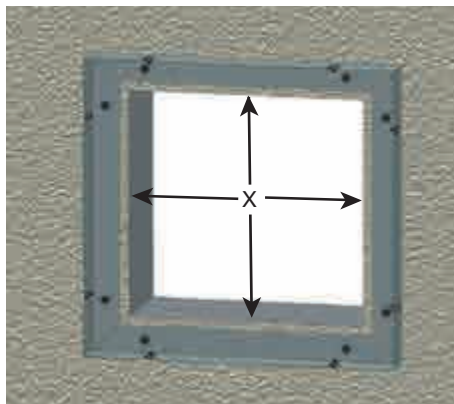

## Installation

1. Cut an appropriate sized hole in the wall based on the 'Wall Opening Size' table above.
2. Locate the wall bracket in the desired installation position and check for potential unit clearance issues.
3. Using the anchoring guidelines on page 1, fasten the wall bracket to the wall. If mounting a size 240 or 300, ensure the sides of the wall bracket with the four U-nuts are on the top and bottom.
4. Caulk the perimeter of the wall bracket to ensure a watertight seal. See Figure 1. Shims or additional sealant methods may be needed for an uneven wall surface.

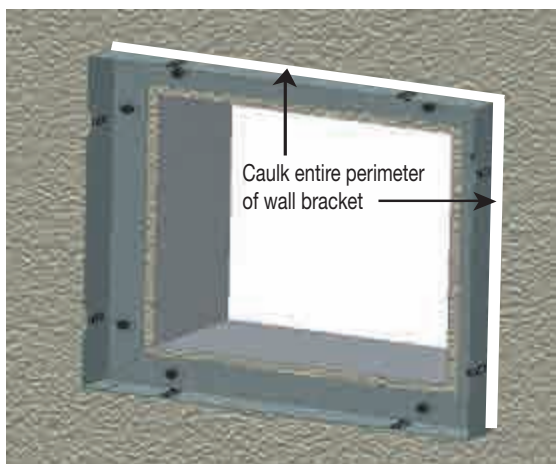

**Figure 1**

5. If the installation requires a backdraft damper, it should be installed in the duct at this time.

6. Lift the fan into place and orient the breather tube and grease trough in a downward position as shown in Figure 2.

### NOTE

Do NOT support the unit by the hoodband during installation.

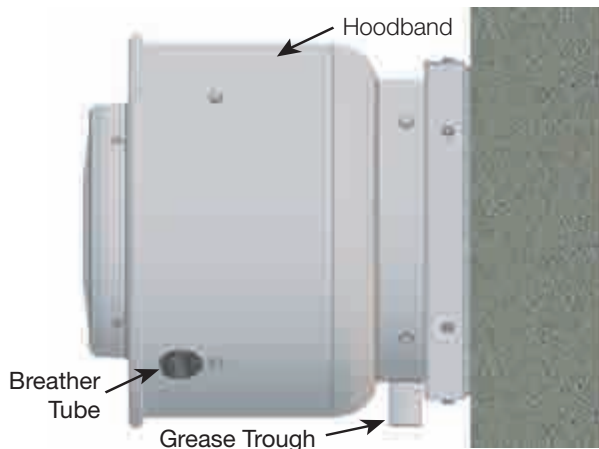

**Figure 2**

7. Secure fan to the wall bracket using the supplied 1/4 - 20 hex bolts. You may need to use a drift, small screwdriver, or the supplied bolts to properly position the U-nuts.
8. Complete fan installation using the instruction manual provided with the fan.